

English

OPERATING MANUAL

Heating Immersion Circulator

MA

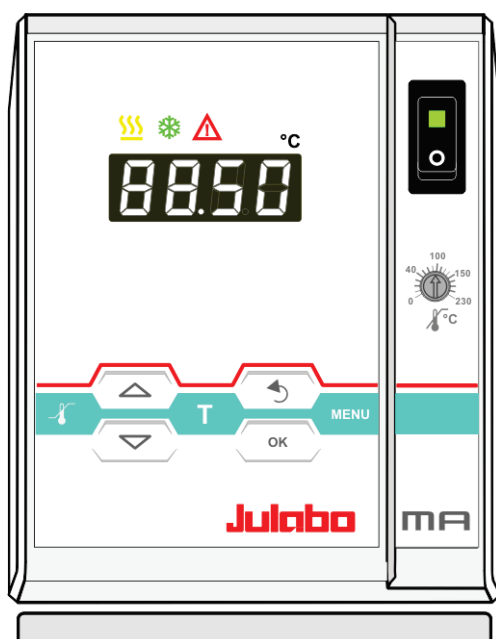

Julabo
THE TEMPERATURE CONTROL COMPANY

JULABO GmbH
77960 Seelbach / Germany
Tel. +49 (0) 7823 / 51-0
Fax +49 (0) 7823 / 24 91
info.de@julabo.com
www.julabo.com

1.951.0332-V3

03/16

Congratulations!

You have made an excellent choice.

JULABO thanks you for the trust you have placed in us.

This operating manual has been designed to help you gain an understanding of the operation and possible applications of our circulators. For optimal utilization of all functions, we recommend that you thoroughly study this manual prior to beginning operation.

The JULABO Quality Management System





Temperature control devices for research and industry are developed, produced, and distributed according to the requirements of ISO 9001 and ISO 14001. Certificate Registration No. 01 100044846

Unpacking and inspecting

Unpack the circulator and accessories and inspect them for possible transport damage. Damage should be reported to the responsible carrier, railway, or postal authority, and a damage report should be requested. These instructions must be followed fully for us to guarantee our full support of your claim for protecting against loss from concealed damage. The form required for filing such a claim will be provided by the carrier.

TABLE OF CONTENTS

Operating manual	5
1. Intended use	5
1.1. Description	5
2. Operator responsibility – Safety recommendations	6
2.1. Disposal.....	8
2.2. Warranty conditions.....	8
2.3. EC Conformity	9
2.4. Technical specifications	11
Operating instructions	13
3. Safety notes for the user	13
3.1. Explanation of safety notes	13
3.2. Explanation of other notes	13
3.3. Safety recommendations	13
4. Operating controls and functional elements.....	16
4.1. Circulator	16
5. Preparations	18
5.1. Installation	18
5.2. Bath fluids.....	19
5.3. Temperature application to external systems	20
5.3.1. Pump set	20
5.3.2. Tubing	21
5.4. Countercooling	22
6. Operating procedures	23
6.1. Power connection.....	23
6.2. Switching on / Start – Stop	23
6.2.1. Switching on the circulator	23
7.  Setting of temperatures	24
7.1. 1-setpoint mode / Direct setting of temperatures	24
7.2. Using the pre-setting in the  menu	24
8.  Safety installations, warning functions	26
8.1. Excess temperature protection	26

8.1.1.	Early warning system, low level protection	27
8.2.	Switch-over from warning to shutdown function	28
8.3.	Over and Sub temperature warning function	29
9.	MENU Menu functions	30
9.1.	MENU PUMP – Setting of pump pressure	31
9.2.	MENU Configuration	32
9.2.1.	Configuration of the mode of the T key	33
9.2.2.	Remote control: activate – deactivate	33
9.2.3.	Automatic / non-automatic start mode	33
9.2.4.	Reset - Factory setting	34
9.3.	MENU Control parameters – Xp, Tv, Tn	34
9.4.	MENU SERIAL - BAUDRATE, PARITY, HANDSHAKE	36
9.5.	MENU ATC - Absolut Temperature Calibration	37
9.5.1.	ATC STATUS - YES / NO	39
9.5.2.	ATC - TYPE: 1 -/ 2 -/ 3 POINT	39
9.5.3.	Example: 3-point calibration	40
9.6.	MENU LIMITS	42
10.	Troubleshooting guide / error messages	43
11.	Electrical connections	45
12.	Remote control	46
12.1.	Setup for remote control	46
12.2.	Communication with a PC or a superordinated data system	46
12.3.	List of commands	47
12.4.	Status messages	48
12.5.	Error messages	48
13.	JULABO Service – Online remote diagnosis	50
14.	Cleaning / repairing the unit	51

Operating manual

1. Intended use

JULABO circulators have been designed to control the temperature of specific fluids in a bath tank.



JULABO circulators are not suitable for direct temperature control of foods, semi-luxury foods and tobacco, or pharmaceutical and medical products. Direct temperature control means unprotected contact of the object with the bath medium (bath fluid).

1.1. Description

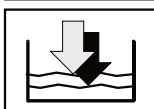
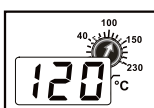
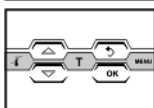

- The circulators are operated via the splash-proof keypad. The implemented microprocessor technology allows to set and to store different values that can be indicated on the MULTI-DISPLAY (LED). Three menu keys facilitate adjusting setpoints, warning and safety functions and menu functions.
- The PID temperature control adapts the heat supplied to the thermal requirements of the bath.
- Absolute Temperature Calibration (ATC3) provides a high temperature stability in the bath. With the 3-point calibration an offset is adjusted at three temperatures to ensure an accurate temperature pattern at the selected spot in the bath over the full temperature range.
- Electrical connections:
 The serial interface RS232 allows modern process technology without additional interface.
 Alarm output for external alarm message or control of JULABO refrigerating baths or solenoid valve (cooling water).
- The excess temperature protection conforming to IEC 61010-2-010 is a safety installation independent from the control circuit. This protection can be indicated and set on the MULTI-DISPLAY (LED).
- The early warning system for low level signals that bath fluid needs to be refilled before the low level protection conforming to IEC 61010-2-010 causes a complete shut-down of the main functional elements.
- The pump capacity (electronically adjustable via the motor speed) enables to adapt to varying conditions for internal and external temperature applications.
- The circulator conforms to the relevant requirements specified by European guidelines.

2. Operator responsibility – Safety recommendations

The products of JULABO ensure safe operation when installed, operated, and maintained according to common safety regulations. This section explains the potential dangers that may arise when operating the circulator and also specifies the most important safety precautions to preclude these dangers as far as possible.

- The operator is responsible for the qualification of the personnel operating the units.
- The personnel operating the units should be regularly instructed about the dangers involved with their job activities as well as measures to avert these dangers.
- Make sure all persons tasked with operating, installing, and maintaining the unit have read and understand the safety information and operating instructions.
- When using hazardous materials or materials that could become hazardous, the circulator may be operated only by persons who are absolutely familiar with these materials and the circulator. These persons must be fully aware of possible risks.

If you have any questions concerning the operation of your unit or the information in this manual, please contact us!

Contact

JULABO GmbH
Gerhard-Juchheim-Strasse 1
77960 Seelbach / Germany

Tel. +49 (0) 7823 / 51-0
Fax +49 (0) 7823 / 24 91
info.de@julabo.com
www.julabo.com

Safety instructions for the operator:

- You have received a product designed for industrial use. Nevertheless, avoid strikes to the housing, vibrations, damage to the operating-element panel (keypad, display), and contamination.
- Make sure the product is checked for proper condition regularly (depending on the conditions of use). Regularly check (at least every 2 years) the proper condition of the mandatory, warning, prohibition and safety labels.
- Make sure that the mains power supply has low impedance to avoid any negative effects on instruments being operated on the same mains.
- This unit is designed for operation in a controlled electromagnetic environment. This means that transmitting devices (e.g., cellular phones) should not be used in the immediate vicinity.
Magnetic radiation may affect other devices with components sensitive to magnetic fields (e.g., monitors). We recommend maintaining a minimum distance of 1 m.
- Permissible ambient temperature: max. 40 °C, min. 5 °C.
- Permissible relative humidity: 50% (40 °C).
- Do not store the unit in an aggressive atmosphere.
- Protect the unit from contamination.
- Do not expose the unit to sunlight.

Appropriate operation

Only qualified personnel is authorized to perform configuration, installation, maintenance and repairs of the circulator.

Routine operation can also be carried out by untrained personnel who should however be instructed by trained personnel.

Use:

The bath can be filled with flammable materials. Fire hazard!



There might be chemical dangers depending on the bath medium used.

Observe all warnings for the used materials (bath fluids) and the respective instructions (safety data sheets).

Insufficient ventilation may result in the formation of explosive mixtures. Only use the unit in well ventilated areas.

Only use recommended materials (bath fluids). Only use non-acid and non corroding materials.

When using hazardous materials or materials that could become hazardous, **the operator must** affix the enclosed safety labels (**1 + 2**) to the front of the unit so they are highly visible:

1		Warning label W00: Colors: yellow, black Danger area. Attention! Observe instructions. (operating manual, safety data sheet)
2 or		Mandatory label M018: Colors: blue, white Carefully read the user information prior to beginning operation. Scope: EU
2		Semi S1-0701 Table A1-2 #9 Carefully read the user information prior to beginning operation. Scope: USA, NAFTA

Particular care and attention is necessary because of the wide operating range.

There are thermal dangers: Burn, scald, hot steam, hot parts and surfaces that can be touched.

	Warning label W26: Colors: yellow, black Hot surface warning. (The label is put on by JULABO)
---	---

Observe the instructions in the manuals for instruments of a different make that you connect to the circulator, particularly the respective safety recommendations. Also observe the pin assignment of plugs and technical specifications of the products.

2.1. Disposal

The circulator contains a back-up battery that supplies voltage to memory chips when the unit is switched off. Do not dispose of the battery with household waste!
Depending on battery regulations in your country, you might be obliged to give back used or defect batteries to gathering places.
The product may be used with oil as bath fluid. These oils fully or partially consist of mineral oil or synthetic oil. For disposal, observe the instructions in the safety data sheets.



Valid in EU countries

See the current official journal of the European Union – WEEE directive. Directive of the European Parliament and of the Council on waste electrical and electronic equipment (WEEE).

This directive requires electrical and electronic equipment marked with a crossed-out trash can to be disposed of separately in an environmentally friendly manner.

Contact an authorized waste management company in your country.

Disposal with household waste (unsorted waste) or similar collections of municipal waste is not permitted!

2.2. Warranty conditions

JULABO GmbH warrants its products against defects in material or in workmanship, when used under appropriate conditions and in accordance with appropriate operating instructions

for a period of ONE YEAR.

Extension of the warranty period – free of charge

2 Years Warranty
1Plus Warranty
Registration free of charge on www.julabo.com

With the '1PLUS warranty' the user receives a free of charge extension to the warranty of up to 24 months, limited to a maximum of 10 000 working hours.

To apply for this extended warranty the user must register the unit on the JULABO web site www.julabo.de, indicating the serial no. The extended warranty will apply from the date of JULABO GmbH's original invoice.

JULABO GmbH reserves the right to decide the validity of any warranty claim. In case of faults arising either due to faulty materials or workmanship, parts will be repaired or replaced free of charge, or a new replacement unit will be supplied.

Any other compensation claims are excluded from this guarantee.

2.3. EC Conformity

EG-Konformitätserklärung nach EG Maschinenrichtlinie 2006/42/EG, Anhang II A
EC-Declaration of Conformity to EC Machinery Directive 2006/42/EC, Annex II A

Hersteller / Manufacturer:

JULABO GmbH
Gerhard-Juchheim-Straße 1
77960 Seelbach / Germany
Tel: +49(0)7823 / 51 - 0



Hiermit erklären wir, dass das nachfolgend bezeichnete Produkt
We hereby declare, that the following product

Produkt / Product: Thermostat / Circulator

Typ / Type: MA, MB, ME

Serien-Nr. / Serial-No.: siehe Typenschild / see type label

aufgrund seiner Konzipierung und Bauart in der von uns in Verkehr gebrachten Ausführung den grundlegenden Sicherheits- und Gesundheitsanforderungen den nachfolgend aufgeführten EG-Richtlinien entspricht.
due to the design and construction, as assembled and marketed by our Company – complies with fundamental safety and health requirements according to the following EC-Directives.

Maschinenrichtlinie 2006/42/EG; Machinery Directive 2006/42/EC
EMV-Richtlinie 2004/108/EG; EMC-Directive 2004/108/EC (bis zum / until 19. April 2016)
EMV-Richtlinie 2014/30/EU; EMC-Directive 2014/30/EU (vom / from 20. April 2016)
RoHS-Richtlinie 2011/65/EU; RoHS-Directive 2011/65/EU

Angewandte harmonisierte Normen und techn. Spezifikationen:

The above-named product is in compliance with the following harmonized standards and technical specifications:

EN 50581 : 2012

Technische Dokumentation zur Beurteilung von Elektro- und Elektronikgeräten hinsichtlich der Beschränkung gefährlicher Stoffe
Technical documentation for the assessment of electrical and electronic products with respect to the restriction of hazardous substances

EN ISO 12100 : 2010

Sicherheit von Maschinen - Allgemeine Gestaltungsleitsätze - Risikobeurteilung und Risikominderung (ISO 12100:2010)
Safety of machinery - General principles for design - Risk assessment and risk reduction (ISO 12100:2010)

EN 61010-1 : 2010

Sicherheitsbestimmungen für elektrische Mess-, Steuer-, Regel- und Laborgeräte, Teil 1: Allgemeine Anforderungen
Safety requirements for electrical equipment for measurement, control, and laboratory use, Part 1: General requirements

EN 61010-2-010 : 2014

Sicherheitsbestimmungen für elektrische Mess-, Steuer-, Regel- und Laborgeräte, Teil 2-010: Besondere Anforderungen an Laborgeräte für das Erhitzen von Stoffen
Safety requirements for electrical equipment for measurement, control, and laboratory use, Part 2-010: Particular requirements for laboratory equipment for the heating of materials

EN 61326-1 : 2013

Elektrische Mess-, Steuer-, Regel- und Laborgeräte- EMV-Anforderungen- Teil 1: Allgemeine Anforderungen
Electrical equipment for measurement, control, and laboratory use - EMC requirements - Part 1: General requirements

Bevollmächtigter für die Zusammenstellung der techn. Unterlagen:

Authorized representative in charge of administering technical documentation:

Hr. Torsten Kauschke, im Hause / on the manufacturer's premises as defined above

Die Konformitätserklärung wurde ausgestellt

The declaration of conformity was issued and valid of

Seelbach, 22.02.2016

M. Juchheim, Geschäftsführer / Managing Director

2016_007_MA-MB-ME-Thermostat_d_e.docx

2.4. Technical specifications

Heating Immersion Circulator		MA
Working temperature range	°C	20 ... 200
Temperature stability	°C	±0,01
Overall dimensions (WxDxH)	cm	13x15x33
Usable bath depth	cm	from 8 to 14.5
Weight	kg	4.0

All measurements have been carried out at: rated voltage and frequency
 operating temperature: 70 °C ambient temperature: 20 °C bath fluid: water
 Technical changes without prior notification reserved.

Mains power connection	V; Hz	208 - 230; 50/60 (perm. range)
Current draw (at 208V)	A	8
Current draw (at 230V)	A	9
Mains power connection	V; Hz	100 - 115; 50/60 (perm. range)
Current draw (at 100V)	A	8
Current draw (at 115V)	A	9

		MA
Temperature selection		digital
via keypad	indication on	MULTI-DISPLAY(LED)
remote control via personal computer		indication on monitor
Temperature indication		MULTI-DISPLAY (LED)
Resolution (-9.99 ... +99.99 = 0.01)	°C	0.01 / 0.1
Absolute Temperature Calibration	°C	±3
Temperature control		PID
Heater wattage (at 230 V)	kW	2,0
Heater wattage (at 115V)	kW	1,0
Electronically adj. pump capacity	stages	1 ... 4
Flow rate max.at 0 bar	l/min	11 ... 16
Pressure max. max. at 0 l	bar	0.23 ... 0.45
Electrical connections:		
External alarm device	Vdc/mA	24-0 / max. 25
Computer interface		RS232
Ambient temperature	°C	5 ... 40

Safety installations according to IEC 61010-2-010:

Excess temperature protection	adjustable from 0 °C ... 230 °C
Low liquid level protection	float switch
Classification according to DIN 12876-1	class III

Supplementary safety installations

Early warning system for low level	float switch
High temperature warning function	optical + audible (in intervals)
Low temperature warning function	optical + audible (in intervals)
Supervision of working sensor	plausibility control
Reciprocal sensor monitoring between working and safety sensors	difference >35 K
Alarm message	optical + audible (permanent)
Warning message	optical + audible (in intervals)

Environmental conditions according to IEC 61 010-1:

Use only indoor.

Altitude up to 2000 m - normal zero.

Ambient temperature: +5 ... +40 °C

Air humidity:

Max. rel. humidity 80 % for temperatures up to +31 °C,

linear decrease down to 50 % relative humidity at a temperature of +40 °C

Max. mains fluctuations of ± 10 % are permissible.

Protection class according to IEC 60 529	IP21
The unit corresponds to Class I	
Overvoltage category	II
Pollution degree	2



Caution:

The unit is not for use in explosive environment

Standards for interference resistance according to EN 61326-1

This unit is an ISM device classified in Group 1 (using high frequency for internal purposes) Class A (industrial and commercial range).

Operating instructions

3. Safety notes for the user

3.1. Explanation of safety notes



In addition to the safety warnings listed, warnings are posted throughout the operating manual. These warnings are designated by an exclamation mark inside an equilateral triangle. “Warning of a dangerous situation (Attention! Please follow the documentation).”

The danger is classified using a signal word.

Read and follow these important instructions for averting dangers.



Warning:

Describes a **possibly** highly dangerous situation. If these instructions are not followed, serious injury and danger to life could result.



Caution:

Describes a **possibly** dangerous situation. If this is not avoided, slight or minor injuries could result. A warning of possible property damage may also be contained in the text.



Notice:

Describes a **possibly** harmful situation. If this is not avoided, the product or anything in its surroundings can be damaged.

3.2. Explanation of other notes



Note!

Draws attention to something special.



Important!

Indicates usage tips and other useful information.



This icon is used in the operating instructions to indicate flashing values or parameters which have to be set or confirmed.

3.3. Safety recommendations

Follow the safety instructions to avoid personal injury and property damage. Also, the valid safety instructions for workplaces must be followed.



- Only connect the unit to a power socket with an earthing contact (PE – protective earth)!
- The power supply plug serves as a safe disconnecting device from the line and must always be easily accessible.
- Place the unit on an even surface on a base made of nonflammable material.

- Do not stay in the area below the unit.
- Make sure you read and understand all instructions and safety precautions listed in this manual before installing or operating your unit.
- Set the excess temperature safety installation at least 25 °C below the fire point of the bath fluid.
- Observe the limited working temperature range when using plastic bath tanks.
- Never operate the unit without bath fluid in the bath.
- Pay attention to the thermal expansion of bath oil during heating to avoid overflowing of the fluid.
- Prevent water from entering the hot bath oil.
- Do not drain the bath fluid while it is hot!
Check the temperature of the bath fluid prior to draining (e.g., by switching the unit on for a short moment).
- Use suitable connecting tubing.
- Avoid sharp bends in the tubing, and maintain a sufficient distance from surrounding walls.
- Make sure that the tubing is securely attached.
- Regularly check the tubing for material defects (e.g., for cracks).
- Never operate damaged or leaking units.
- Always turn off the unit and disconnect the mains cable from the power source before performing any service or maintenance procedures, or before moving the unit.
- Always turn off the unit and disconnect the mains cable from the power source before cleaning the unit.
- Always empty the bath before moving the unit.
- Transport the unit with care.
- Sudden jolts or drops may cause damage in the interior of the unit.
- Observe all warning labels.
- Never remove warning labels.
- Never operate units with damaged mains power cables.
- Repairs are to be carried out only by qualified service personnel.



- Some parts of the bath tank and the pump connections may become extremely hot during continuous operation. Therefore, exercise particular caution when touching these parts.



Caution:

The temperature controlling i.e. of fluids in a reactor constitutes normal circulator practice.

We do not know which substances are contained within these vessels. Many substances are:

- inflammable, easily ignited or explosive
- hazardous to health
- environmentally unsafe

i.e.: **dangerous**

The user alone is responsible for the handling of these substances!

The following questions shall help to recognize possible dangers and to reduce the risks to a minimum.

- Are all tubes and electrical cables connected and installed?
Note:
sharp edges, hot surfaces in operation, moving machine parts, etc.
- Do dangerous steams or gases arise when heating?
Is an exhaust needed when working?
- What to do when a dangerous substance was spilled on or in the unit?
Before starting to work, obtain information concerning the substance and determine the method of decontamination.



Notice: Check the safety installations at least twice a year!

- Excess temperature protection according to IEC 61010-2-010.
With a screwdriver turn back the adjustable excess temperature protection until the shut-down point (actual temperature).
- Low level protection according to IEC 61010-2-010.
To check the function of the float, it can be manually lowered with a screwdriver for example.

4. Operating controls and functional elements

4.1. Circulator

Front view

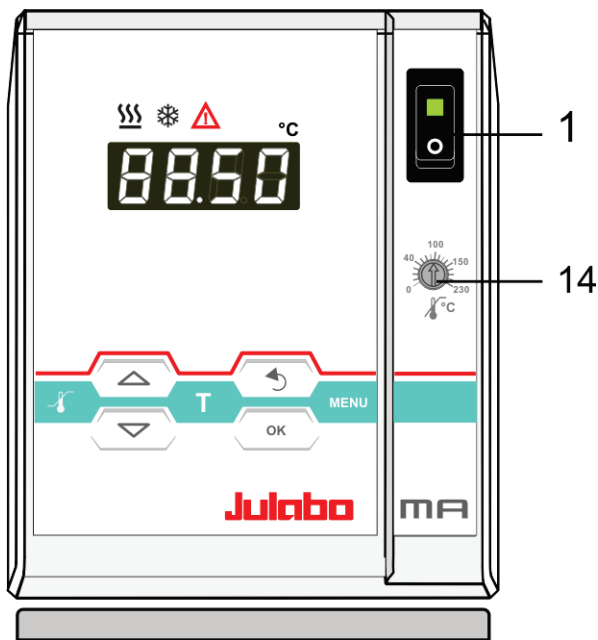

Rear view

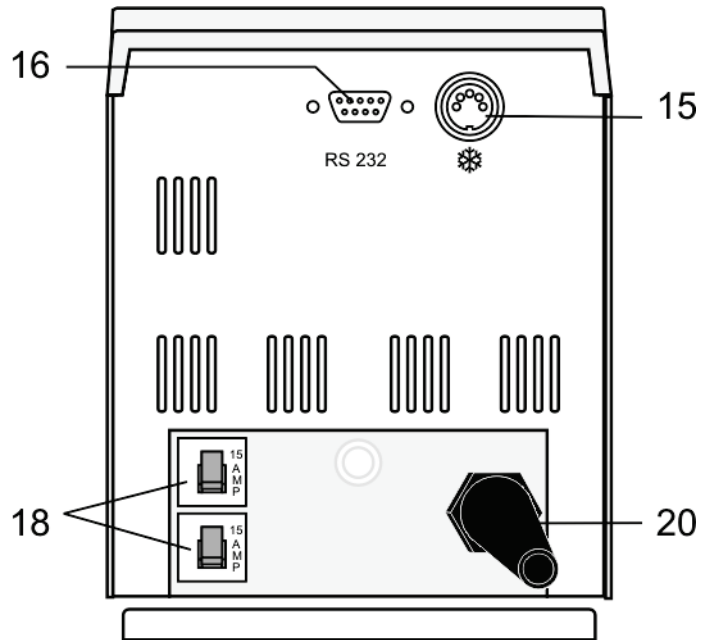

- 1  Mains power switch, illuminated

Navigation keys

- 2  **OK**
1. Key: >OK< Start / Stop (pump / heater)
 2. >OK< in the menu Menu item / select submenu for setting
Save set value
Save selected parameter
- A beep signals the end of setting



After the actions Start, Stop and change from VFD Display to standard display the key **OK** is locked for a short time. The above graph "front side" shows an example for standard display.



- 3  **Return**
1. Key: >Return< Stop (pump / heater)
 2. >Return< in the menu one menu level down
Correction function for parameters or values (prior to OK)



immediately back to standard display



 -  icon for „keep key pressed down“.

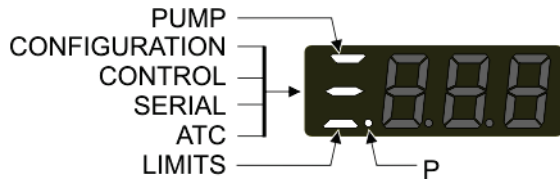

- 4  1. Key: >Up / Down <temperature – increase/decrease setpoint
Push key quickly for single steps,
Keep key pressed for fast change.
-  2. >Up/Down< in the menu selection of menu items / parameters





Navigation aids

Flashing segments show the position within the structure of the menu. Item „P“ flashes simultaneously in the submenu.

Menu keys

- 5  Key: start the menu > warning and safety values<
- 6  Key: start the menu >temperature setpoints<
- 7  Key: display of MENU structure

- 10  MULTI-DISPLAY (LED) temperature indication, menu indication

- 11  Control indicator –Heating

- 12  Control indicator – Cooling (without function)

- 13  Control indicator – Alarm

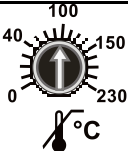
- 14  Adjustable excess temperature protection according to IEC 61010-2-010

- 15  Socket: control cable of JULABO refrigerated circulator or output for alarm messages

- 16  Interface RS232: remote control via personal computer

- 18  Mains circuit breakers (resettable) 15 A

- 20 Mains power cable with plug

5. Preparations

5.1. Installation



Caution:

Securely fix the immersion circulator. The heater may not be in contact with the wall of the bath tank. Keep a distance of at least 15 mm. Units not adequately fixed may drop into the bath tank.

Danger of electric shock!

First pull out the power plug to disconnect the unit from the power supply net. Then take the immersion circulator out of the bath tank.

Make a service technician check the instrument before it is used again.

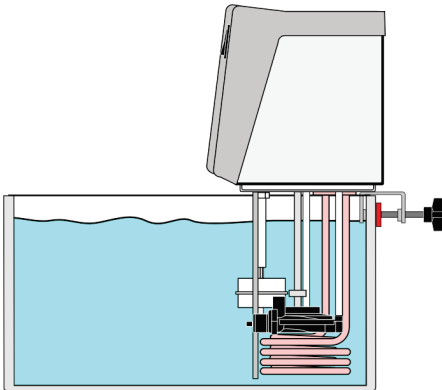

- Place the unit on an even surface on a pad made of non-flammable material.
- The heating immersion circulator is mounted using a bath attachment clamp (21) designed for bath wall thicknesses up to 26 mm.

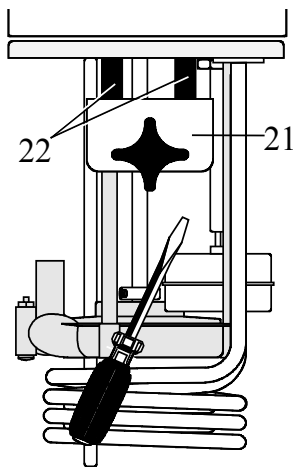

- Use the two sleeves (22) supplied with the unit to reduce the immersion depth from 165 mm to 145 mm (see drawing).
- For use with glass vessels an upright stand rod, available as optional accessory (order no. 8 970 022) may be attached.

5.2. Bath fluids



Caution:

Carefully read the safety data sheet of the bath fluid used, particularly with regard to the fire point!

If a bath fluid with a fire point of ≤ 65 °C is used, only supervised operation is possible.

Water: The quality of water depends on local conditions.

- Due to the high concentration of lime, hard water is not suitable for temperature control because it leads to calcification in the bath.
- Ferrous water can cause corrosion - even on stainless steel.
- Chloric water can cause pitting corrosion.
- Distilled and deionized water is unsuitable. Their special properties cause corrosion in the bath, even in stainless steel.

Recommended bath fluids:

Bath fluid	Temperature range
soft/decalcified water	5 °C to 80 °C

JULABO bath fluids

JULABO Description		Thermal G	Thermal M	Thermal HS
Order Number	10 liters	8 940 124	8 940 100	8 940 102
	5 liters	8 940 125	8 940 101	8 940 103
Temperature range	°C	-30 ... 80	40 ... 170	20 ...250
Flash point	°C	--	284	270
Fire point	°C	--	306	>360
Color		light yellow	clear	light brown

JULABO Description		Thermal H10	Thermal H20S	Thermal H200
Order Number	10 liters	8 940 114	8 940 108	8 940 134
	5 liters	8 940 115	8 940 109	8 940 135
Temperature range	°C	-20 ... 180	0 ... 220	60 ...200
Flash point	°C	190	230	292
Fire point	°C	216	274	334
Color		clear	light brown	clear



See website for list of recommended bath fluids.

ATTENTION: The maximum permissible viscosity is 50 mm² /s



Caution:

Fire or other dangers when using bath fluids that are not recommended:

Please contact JULABO before using other than recommended bath fluids. Use only nonacidic and noncorrosive bath fluids.

JULABO assumes no liability for damage caused by the selection of an unsuitable bath liquid.

Unsuitable bath fluids are fluids which, e.g.,

- are highly viscous (much higher than recommended at the respective working temperature)
- have a low viscosity and have creep characteristics
- have corrosive characteristics or
- tend to crack.
- **No liability for use of other bath fluids!**

5.3. Temperature application to external systems



Caution: Securely attach all tubing to prevent slipping.

If the circulator is operated without external system, close the pump connector (24a) with the cap nut.

The circulator is used for temperature application to external, closed systems (loop circuit).

5.3.1. Pump set

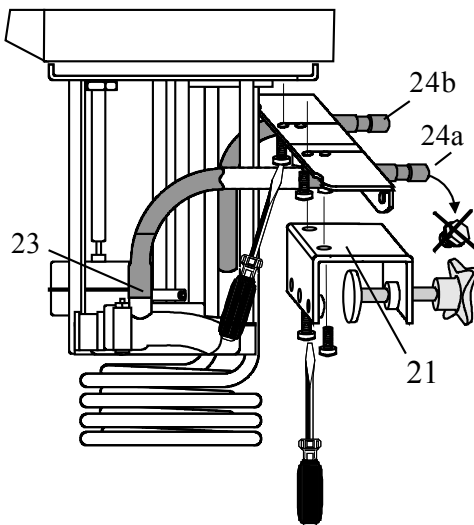

Mounting the pump set:

- Remove the bath attachment clamp (21).
- Screw the pump set to the circulator, and then fix the bath attachment clamp to the pump set.
- Slide the short piece of tubing supplied with the pump set onto the short pump nozzle and the pump connector (23).
- Thus the total immersion depth is reduced to 145 mm.
- Adjusting the pump for external bath circulation see example D - MENU PUMP.

Connecting an external system:

- Unscrew the collar nuts from the pump connector (24a).
- Slide the tubing onto the pump connector for feed (24a) and return flow (24b) and secure with hose clamps

Accessories

Order No.	Description
8 970 140	Pump set

5.3.2. Tubing

Recommended tubing:

Order No.	Length		Temperature range
8 930 008	1 m	CR [®] tubing 8 mm inner dia.	-20 °C to 120 °C
8 930 010	1 m	CR [®] tubing 10 mm inner dia.	-20 °C to 120 °C
8 930 108	1 m	Viton tubing 8 mm inner dia.	-50 °C to 200 °C
8 930 110	1 m	Viton tubing 10 mm inner dia.	-50 °C to 200 °C
8 930 410	1 m	Insulation for tubing 8 mm or 10 mm inner dia.	-50 °C to 100 °C
8 970 480		2 tubing clamps. size 1, tubing 8 mm inner dia.	
8 970 481		2 tubing clamps. size 2, tubing 10 or 12 mm inner dia.	
8 930 209	0.5 m	Metal tubing, triple insulated, M16x1 *	-100 °C to +350 °C
8 930 210	1.0 m		
8 930 211	1.5 m		
8 930 214	3.0 m		
8 930 220	0.5 m	Metal tubing, insulated, M16x1 *	-50 °C to +200 °C
8 930 221	1.0 m		
8 930 222	1.5 m		
8 930 223	3.0 m		



*) Adapter for metal tubing M10x1 on M16x1 Order No. 8 970 444



Warning: Tubing:

At high working temperatures the tubing used for temperature application and cooling water supply represents a danger source.

A damaged tubing line may cause hot bath fluid to be pumped out within a short time.

This may result in:

- Burning of skin
- Difficulties in breathing due to hot atmosphere

Safety recommendations

- Employ suitable connecting tubing.
- Make sure that the tubing is securely attached.
- Avoid sharp bends in the tubing, and maintain a sufficient distance from surrounding walls.
- Regularly check the tubing for material defects (e.g. for cracks).
- Preventive maintenance: Replace the tubing from time to time.

5.4. Countercooling



Notice:

Securely attach all tubing to prevent slipping.

Observe the laws and regulations of the water distribution company valid in the location where the unit is operated.

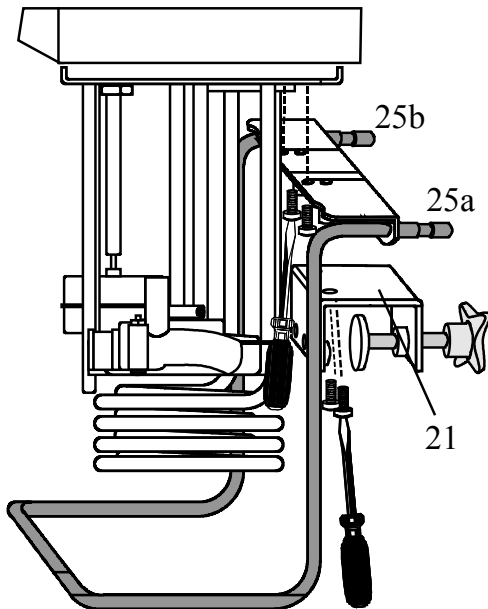

For applications near the ambient temperature, the cooling coil (order no. 8 970 105) must be connected to the water mains.

Mounting the cooling coil:

- Remove the bath attachment clamp (21).
- Screw the cooling coil to the circulator, and then fix the bath attachment clamp to the cooling coil.
- Thus the total immersion depth is reduced to 145 mm.

Using tubing, connect the cooling coil (25a) to the tap water supply, and lead the tap water in a sink through the return connector (25b).

- ⓘ A specific water flow rate of 45 ml/minute is sufficient to compensate for the characteristic temperature.

6. Operating procedures

6.1. Power connection



Caution:

- Only connect the unit to a power socket with earthing contact (PE – protective earth)!
- The power supply plug serves as safe disconnecting device from the line and must be always easily accessible.
- Never operate equipment with damaged mains power cables.
- Regularly check the mains power cables for material defects (e.g. for cracks).
- We disclaim all liability for damage caused by incorrect line voltages!

Check to make sure that the line voltage matches the supply voltage specified on the identification plate.

6.2. Switching on / Start – Stop

6.2.1. Switching on the circulator



Switching on:

- Turn on the mains power switch (1).
- ① The unit performs a self-test. All segments of the 4-digit MULTI-DISPLAY (LED) and all indicator lights will illuminate. Then the software version (example: tt 2, V1.12, b004)) appears. The display „OFF“ or „R OFF“ indicates the unit is ready to operate.
- ① The circulator enters the operating mode activated before switching the circulator off:
- keypad control mode** (manual operation)
 - or
 - remote control mode** (operation via personal computer).

Start:



- Press **OK** key.
The actual bath temperature is displayed on the LED-DISPLAY. The circulating pump starts with a slight delay.

Stop:

- Press **OK** key.
or
Keep **↶** **🕒** key pressed.
The LED -DISPLAY indicates the message "OFF".

7. Setting of temperatures

The function of the  key is configurable.

1. If the key is pressed, normally only one adjustable working temperature is displayed (factory setting).
2. Using the Menu Configuration which is started by pressing the  key a menu with three pre-set setpoints can be assigned to the  key.

① Press  key if a value is to be retained.





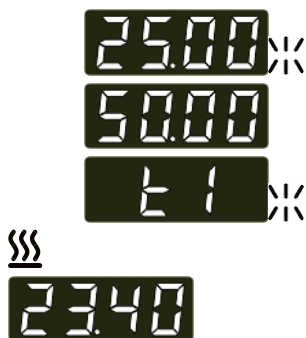

7.1. 1-setpoint mode / Direct setting of temperatures

The circulator uses the setpoint of t1 or t2 or t3 for temperature control.

The indicated setpoint temperature can be changed directly any time.

Example: change 25.00 °C to 50.00 °C



1. By pressing the key  the circulator switches to the active >Setpoint< in the example on the left > t1 25.00°C<. The integer digits flash  (example: <25>).
2. Change the value by pressing the keys  and  to 50.00 °C and confirm by pressing the key . The decimal digits flash and can be adjusted if desired. Confirm once more by pressing the  key. The end of the adjustment is signalled by the flashing message >t1<

① If the „Up / Down“ keys   are pressed immediately instead of pressing the key  this is called direct temperature setting.

① The circulator uses the new working temperature value for temperature control.

① The temperatures can be set in start or stop mode.

7.2. Using the pre-setting in the menu

Factory setting:

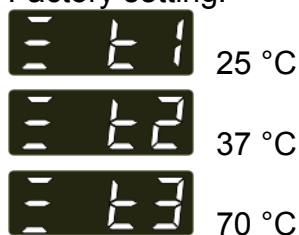

Press the  key to call up the menu for temperature setting. 3 different working temperatures can be adjusted. Their values are freely adjustable with the working temperature range.

Important:

Prior to the adjustment switch-over to the 3-temperature mode has to be effected in the menu configuration.

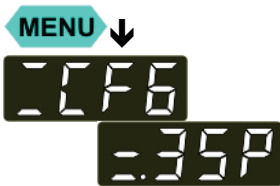

Refer to page 33 for switch-over to 3-temperature-mode

CFG = CONFIGURATION

3SP = 3 SETPOINT

Setting of working temperature in the **T menu**

1. Press the key **T**. The value >tx< ✱ flashes
2. Select SETPOINT >t 1< or >t 2< or >t 3< using the key ▼ or ▲.
3. Confirm by pressing the **OK** key.

ⓘ The circulator uses the new working temperature value for temperature control.

Example: setting / adjustment of of pre-settings of "t 3"

1. Press the **T** key. The parameter >tx< flashes.
2. Select the setpoint >t3< by pressing ▼ or ▲.
3. Keep the key **OK** ⌚ pressed until the integer digits flash ✱ (example: <70>)
4. Change the value by pressing ▼ and ▲ to 85.00 °C and confirm by pressing the **OK** key. The decimal digits flash ✱ and can be adjusted if desired. Confirm once more by pressing the **OK** key. Example on the left: SETPOINT >t3< / 85.00. The end of the adjustment is signaled by the flashing message >t3<



- ⓘ If the active setpoint (SETPNT) is changed, the new value is immediately used for the control of the working temperature. The heater control indicator flashes.
- ⓘ If the other two setpoints (not activated for control) are changed the **T** MENU has to be left by pressing the ↺ key after the decimal digits have been confirmed





Notice: Refer to chapter 9.6. MENU LIMITS

8. Safety installations, warning functions

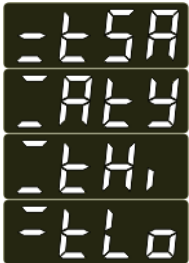

Check the safety installations at least twice a year! Refer to (page 15)



Settings for the excess temperature protection > **tSA**< and for the warning functions for high > **tHi**< and low > **tLo**< temperature are made in a menu which is called up by pressing the key .

Menu item > **Aty** (ALARM-TYPE)< allows choosing between a warning and an alarm cut-off for the menu items > **tHi** < and > **tLo**<.

8.1. Excess temperature protection

This excess temperature protection is independent of the control circuit. When activated heater and circulating pump are completely shut down.

The alarm is indicated by optical and audible signals (continuous tone) and the error message "ALARM-CODE **14**" appears on the MULTI-DISPLAY (LED)



Setting range: 20 °C ... 230 °C

ⓘ Rough setting can be effected by using the temperature scale.

Exact setting:

1. Press the key  to display menu > **tSA** <.
2. Press the **OK** key and the set shutdown value is indicated.

Set the new shutdown value within 30 seconds using a screwdriver. The value is indicated on the MULTI-DISPLAY (LED)
Example: > **tSA** < / 100 °C

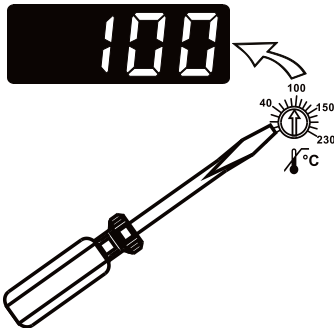

Recommendation:

Set the excess temperature protection at 5 °C to 10 °C above the working temperature setpoint.



Warning:

The excess temperature protection **must** be set at least 25 °C below the fire point of the bath fluid used!

In case of wrong setting there is a fire hazard!

We disclaim all liability for damage caused by wrong settings!

8.1.1. Early warning system, low level protection



Warning:

For refill always use the same bath fluid type that is already in the bath.
Bath oils must not contain any water contaminants and should be pre-heated to the actual bath temperature!
Explosion hazard at higher temperatures!

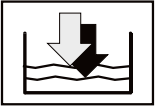

(patented)

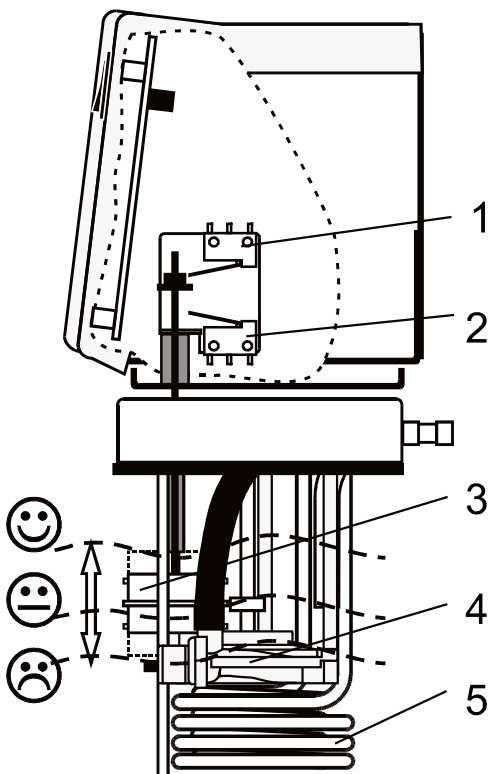

This low level protection is independent of the control circuit and is divided in two sections.

1. Switch in stage 1 recognizes a defined fluid level 😊.

An audible warning (interval tone) sounds and on the MULTI-DISPLAY (LED) the message "E 40" appears.

Refill bath fluid!

2. Switch in stage 2 recognizes a low fluid level ☹️.
If stage 2 of the low level protection device (according to IEC 61010-2-010) is triggered, a complete shutdown of the heater and circulating pump is effected.
A continuous alarm tone sounds and a message >CODE 01< appears on the MULTI-DISPLAY (LED).

Turn off the unit with the mains switch, refill bath fluid and turn the unit on again!

3. Float
4. Circulating pump
5. Heater





8.2. Switch-over from warning to shutdown function



If a shutdown of functional elements (e.g. heater, circulating pump) is required when the limit values are exceeded or undercut the circulator can be changed over from warning function >WARNING< to shutdown function >ALARM<.

Factory setting:
>0 = WARNING<





1. Press the key .
2. Select the menu >Aty (ALARM-TYPE)< by pressing the  key.
3. Press the **OK** key and the set parameter will flash .
(Example: 0)
4. Change the parameter by pressing the  key and confirm by pressing the **OK** key.
or
press the  key if the parameter is to be retained.

① Setting >0 = WARNING<

A mere warning function with optical and audible warning signal (interval tone) A message appears on the MULTI-DISPLAY (LED):





 or 
OVERTMP SUBTEMP

• Setting >1 = ALARM<

Temperature limit with shutdown of heater and circulating pump. An audible alarm sounds (continuous tone) and a message appears on the MULTI-DISPLAY (LED):



 or 
OVERTMP SUBTEMP

8.3. Over and Sub temperature warning function

Factory settings:

Over temperature
t High 205 °C

Sub temperature
t Low -55 °C

If the observance of a working temperature value $>t_3<$ has to be supervised for a sensitive temperature application, then set over and sub temperature warning values. In the example below the setpoint $>t_3<$ 85 °C is surrounded by the values $>t_{\text{High}}<$ 87 °C and $>t_{\text{Low}}<$ 83 °C. The electronics immediately register if the actual temperature breaches one of the set limit values. The resulting reaction is defined in the menu item $>A_{\text{ty}}<$ (ALARM-TYPE) refer to (page 28).

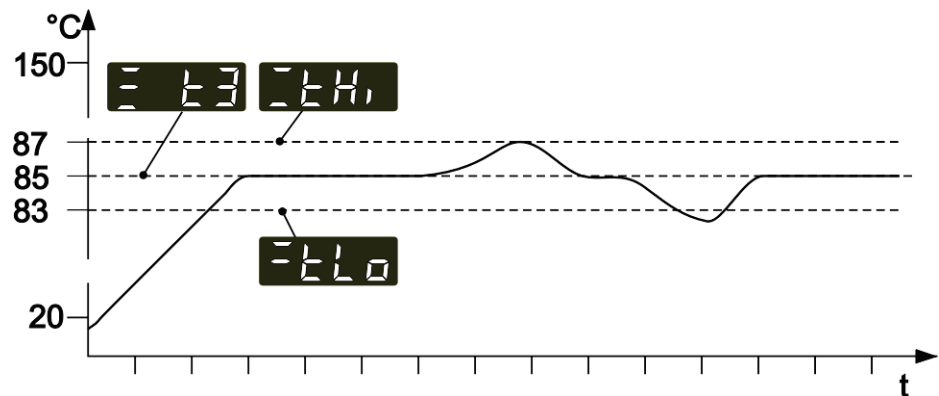

1. Press the key
2. By pressing the or key select the menu $>t_{\text{High}}<$ or $>t_{\text{Low}}<$.
3. Press the key. The integer digits flash.
4. Change the values to 87. °C and/or 83. °C by pressing the and key and confirm with the key. The decimal digits flash and can be adjusted if desired. Confirm once more by pressing the key. See above examples.

i The warning functions are only activated if the actual bath temperature remains within the set limit values for 3 seconds after switch-on.



Recommendation:

Set the over temperature warning value $>t_{\text{High}}<$ 5 °C to 10 °C above the working temperature setpoint.

Set the sub temperature warning value $>t_{\text{Low}}<$ 5 °C to 10 °C below the working temperature setpoint.

9. MENU Menu functions

MENU ↓

➤ Menu level 1

➤ 

➤ 

➤ 

➤ 

➤ 

➤ 

➤ 

➤ 

➤ 

➤ 

➤ 

➤ 

➤ 

➤ 

➤  ATC

➤ 

➤ 

➤ 

➤ 

➤ 

➤ 

➤ 

➤ 

The term „Menu functions“ refers to settings such as

>Pu< - Electronically adjustable pump capacity page 31

>CFG< - Configuration of the unit page 32

>3SP< - 3-setpoint mode

>rt< - REMOTE – on / off (remote control via RS232)

>Aut < – AUTOSTART on / off

>rST< - RESET – factory settings

PID Control parameters page 34

Control parameter XP

Control parameter Tn

Control parameter Tv

Adjustable interface parameters page 36

>br< - Baudrate

>Pty< - Parity

>HS< - Handshake

• ATC - Absolute Temperature Calibration page 36

>Sta< - ATC status

>tyP< - Type

>1. point<, >2. point < or >3. point < calibration

2 values per calibration point

ttx = Defined temperature value of the calibration point.

This value is automatically stored with >Ctx< and can be indicated for control purposes.

Ctx = The „Calibration value“ is determined with a temperature measuring device and stored under menu item > Ctx <.

Limitations of temperature page 42

>SPHigh< - Maximum setpoint

>SPLow< - Minimum setpoint

9.1. MENU PUMP – Setting of pump pressure



The capacity of the circulating pump is set by adjusting the motor speed

Settings: stage 1 ... 4

Factory setting:
stage 1

Flow rate: 11 ... 16 l/m
Pump pressure: 0,22 ... 0,45 bar



1. Press the **MENU** key. Menu >Pu< is indicated.
2. Press the **OK** key. The set parameter flashes (example: > 2<)
3. Change the parameter by pressing or and confirm by pressing the **OK** key.
or
Press the key if the parameter is to be retained.

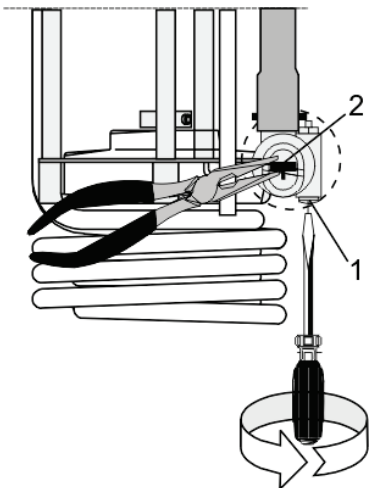

The pump flow is pre-adjusted in the factory and can be modified to suit user requirements.

- Using a screwdriver turn the screw (1) anti-clockwise by 360°.
- Using flat pliers turn the marking of the slide (2) to the desired position.
- Tighten the screw.

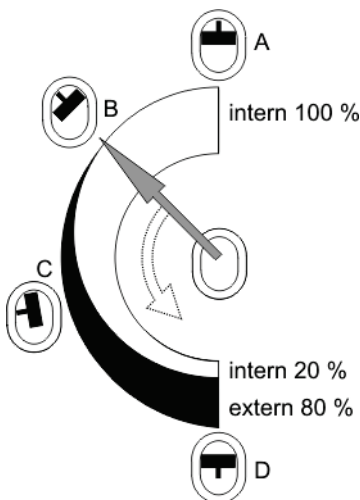

Examples:













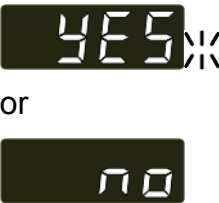

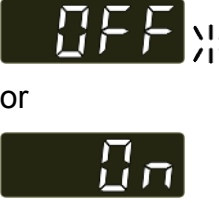

Internal applications in the bath

- A 100 % internal bath circulation
(for large bath tanks)
- B Reduced internal bath circulation
(for smooth surface of bath fluid)

External/internal applications

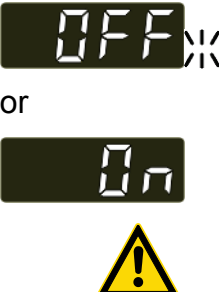
- C 40 % external discharge,
60 % internal circulation
(for large bath tanks)
- D 80 % external discharge,
20 % internal circulation
(for small bath tanks)

9.2. MENU Configuration

<p>Menu level 1</p> 	<p>CFG = MENU CONFIGURATION</p> <p>① A RESET can be effected only in the >OFF< mode. Switch off circulator by pressing the OK key and call up the menu CONFIGURATION.</p>	
<p>Level 2</p>	<p>Parameter level</p>	<p>① Press the key  if a parameter is to be retained. Correction function for parameters and values (prior to OK).</p>
		<p>>3SP< - Switch on and off the 3-setpoint mode</p> <p>① The parameter flashes, set by pressing   + OK</p> <p>① >YES< - This function can be used by pressing the  key. (refer to page 24)</p>
		<p>>rt< - Switch on and off remote control</p> <ul style="list-style-type: none"> The parameter flashes, set by pressing   + OK <p>① For remote control refer to 45</p> <p>①   Connect RS232 with PC</p>
		<p>>Aut< - Switch on and off autostart</p> <ul style="list-style-type: none"> The parameter flashes, set by pressing   + OK <p>AUTOSTART on AUTOSTART off.</p> <p>See WARNING page 34</p>
		<p>>rSt< (RESET) - Use this to reset all values to factory setting.</p> <ul style="list-style-type: none"> Return to factory settings by pressing OK <p>① During the message – init - all parameters are reset to factory settings.</p>

9.2.1. Configuration of the mode of the key



Factory setting: no



Pressing the  key normally indicated only one working temperature which can be individually adjusted.

The configuration opens a menu with 3 setpoints which can be pre-set.

>no< 1-temperature mode
>YES< 3-temperature mode

9.2.2. Remote control: activate – deactivate



Factory setting: OFF



The circulator is to be prepared for remote control by a personal computer via the serial interface RS232: Set the menu item >>rt< = remote< from >OFF< to >On<.

>OFF< No remote control via RS232

>On< Remote control via RS232

The display changes from



keypad control mode (manual operation) to

remote control mode (operation via personal computer).

9.2.3. Automatic / non-automatic start mode

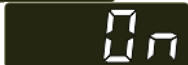
⇒ AUTOSTART on.

⇒ AUTOSTART off.

Notice:

The circulator has been configured and delivered by JULABO in accordance with the NAMUR recommendations. This means for the start mode that the unit must enter a safe operating status after a power failure. This safe operating status is indicated by the message „OFF“ or „r OFF“ on the MULTI-DISPLAY (LED).

A complete, all-pole shutdown of the main functional elements such as heater and pump motor is effected.

The values set on the circulator remain saved and the unit is restarted by pressing the start/stop key in manual control.

In remote control mode the values need to be resent by the PC via the interface.

If such a safety standard is not required, the NAMUR recommendations can be bypassed with the AUTOSTART function thus allowing a direct start of the circulator by pressing the mains switch or using a timer.



Warning

For supervised or unsupervised operation with the “AUTOSTART“ function avoid any hazardous situation to persons or property
Take care to fully observe the safety and warning functions of the circulator.

9.2.4. Reset - Factory setting



>YES< resets all values to factory setting.



① A >rSt< RESET can be effected in the >OFF< mode only.
Switch off the circulator by pressing the key **OK** and call up the menu CONFIGURATION.



① During the message – init - all parameters are reset to factory settings











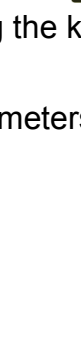

9.3. MENU Control parameters – Xp, Tv, Tn

Menu level 1

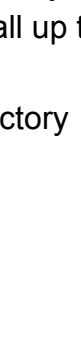

OK ↓

In most cases the control parameters preset in the factory are adequate for achieving an optimum temperature sequence.
The control parameters allow adjustment to special control processes..

Level 2	Parameter level	Press the  key if a parameter is to be retained. Correction function for parameters or values (prior to OK)
	 0.1 ... 99.9	Proportional range >Xp< • The parameter flashes, switch by pressing   and OK
	 3 ... 9999	Reset time >Tn< (Integral component) • The parameter flashes, switch by pressing   and OK
	 0 ... 999	Lead time >Tv< (Differential component) • The parameter flashes, switch by pressing   and OK



Setting range:
0.1 ... 99.9

Proportional range >Xp<

The proportional range is the range below the setpoint in which the control circuit reduces the heating capacity from 100% to 0 %



Setting range:
3 ... 9999

Reset time >Tn< (Integral component)

Compensation of the remaining control deviation due to proportional regulation. An insufficient reset time may cause instabilities. Excessive reset times will result in unnecessary prolongation of compensation of the control difference.



Setting range:
0 ... 999

Lead time >Tv< (Differential component)

The differential component reduces the transient time. An insufficient lead time will prolong the time required for compensation of disturbance effects and cause high overshooting during run-up. An excessive lead time could cause instabilities (oscillations)

Optimization instructions for the PID control parameters

Optimum setting

Control parameters XP-, TN-, TV- INTERNAL as well as -EXTERNAL

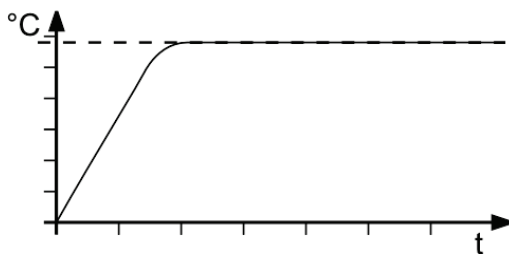

The heat-up curve reveals possible faulty settings of the control parameter.

Inappropriate settings may produce the following heat-up curves:

Xp too low

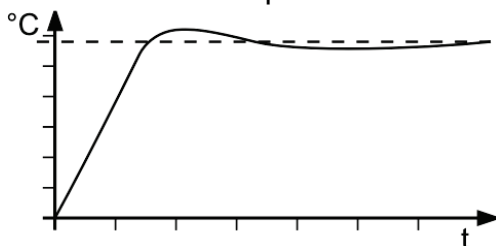

Tv/Tn too low

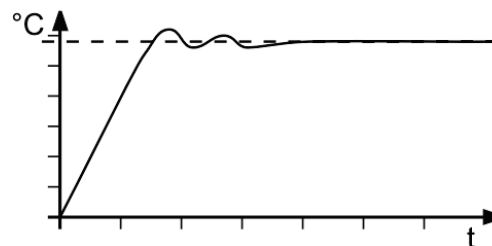

Xp too high or Tv too high

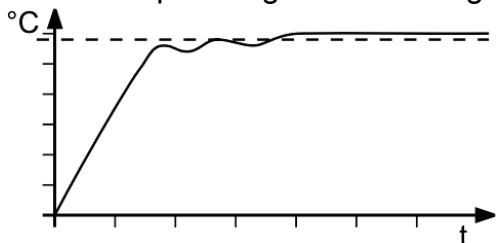

Tv/Tn too high or Xp too high

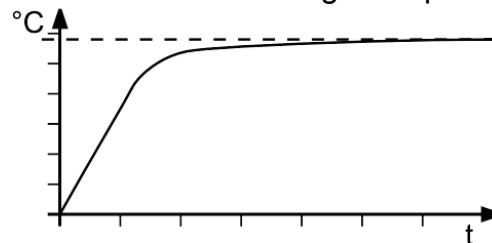

9.4. MENU SERIAL - BAUDRATE, PARITY, HANDSHAKE

Menu level 1



For communication between circulator and a PC or a superordinated process control system the interface parameters of both units must be identical.

Factory settings:
4800 Baud
even
hardware handshake

Level 2

Parameter level

ⓘ Press the key if a parameter is to be retained.

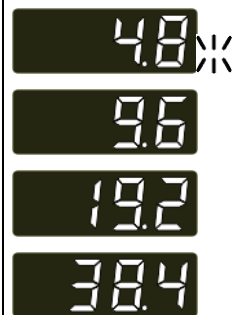

>br< - BAUDRATE

- The parameter flashes, switch by pressing and
- | | |
|--------|------------|
| 4.8 = | 4800 Baud |
| 9.6 = | 9600 Baud |
| 19.2 = | 19200 Baud |
| 38.4 = | 38400 Baud |



>PtY< - PARITY

- The parameter flashes, switch by pressing and
- | | | |
|---|-------|-----------------------------|
| 0 | no: | Datenbits = 8; Stopbits = 1 |
| 1 | odd: | Datenbits = 7; Stopbits = 1 |
| 2 | even: | Datenbits = 7; Stopbits = 1 |

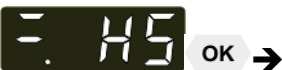

>HS< - HANDSHAKE

- The parameter flashes, switch by pressing and
- | | |
|-------------------|----------------------|
| Xon/Xoff-protocol | (Software handshake) |
| Protocol RTS/CTS | (Hardware handshake) |

9.5. MENU ATC - Absolut Temperature Calibration



ATC serves to compensate a temperature difference that might occur between circulator and a defined measuring point in the bath tank because of physical properties.

Example:
1-point calibration

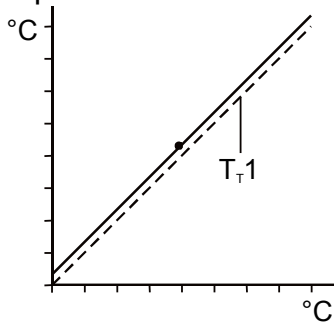

3-point calibration

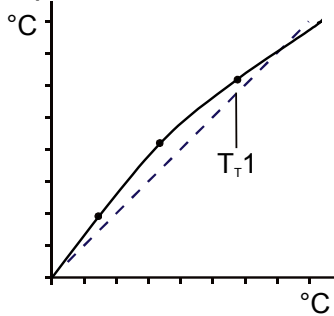

T_T 1 = Original curve

Principle:

For ATC calibration, in steady state the bath temperature at the location of the temperature sensor (CT) is determined at the respective adjusted working temperature. This value is then set on the circulator in the menu >ATCalibration< under menu item >Ctx<. This can be a 1-point, 2-point or 3-point calibration.

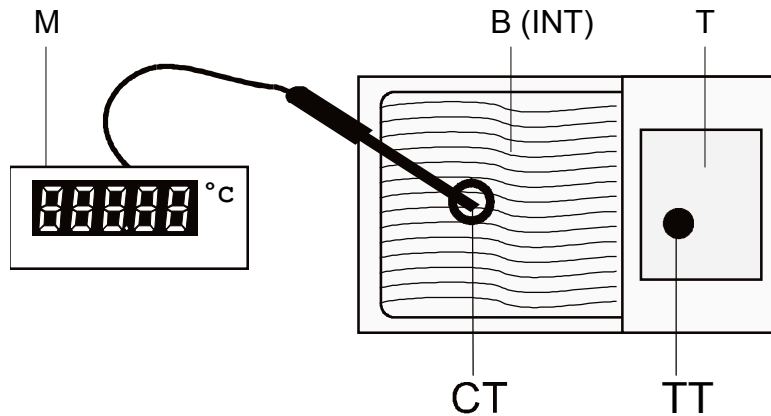







































- M = Temperature measuring instrument with temperature sensor
- B = Bath tank (INTernal or EXTernal)
- T = circulator
- CT = Temperature on measuring point
- TT = Temperature on circulator

Menu level 1



<p>Level 2</p>	<p>Parameter level</p>	<p>ⓘ Press the key if parameter is to be retained. Correction function for parameters or values (prior to OK).</p>
	<p></p> <p>or</p> <p></p>	<p>>StA< - ATC Status</p> <ul style="list-style-type: none"> • The parameter flashes, switch by pressing and and <p>ⓘ >NO< Carry out an ATC calibration</p> <p>ⓘ >YES< return to standard operation after calibration.</p>

Menu functions

 	  	<p>>tYP< - ATC TYPE</p> <ul style="list-style-type: none"> The parameter flashes, switch by pressing   and  ① A >1-point<, >2-point< or >3-point< calibration can be carried out.
 	 	<p>The value > tt1< is only indicated</p> <ul style="list-style-type: none"> ① In addition the measured temperature value >Ct 1< is saved during the next step. Integer digits flash, set by pressing   +  Decimal digits flash, set by pressing   + 
<p>① If only a 1-point calibration is carried out, the following menu items are not indicated anymore</p>		
		<p>The value > tt2< is only indicated</p> <ul style="list-style-type: none"> ① In addition the measured temperature value >Ct 2< is saved during the next step.
		<ul style="list-style-type: none"> Integer digits flash, set by pressing   +  Decimal digits flash, set by pressing   + 
<p>① If only a 2-point calibration is carried out, the following menu items are not indicated anymore</p>		
		<p>The value > tt3< is only indicated</p> <ul style="list-style-type: none"> ① In addition the measured temperature value >Ct 3< is saved during the next step.
		<ul style="list-style-type: none"> Integer digits flash, set by pressing   +  Decimal digits flash, set by pressing   + 

9.5.1. ATC STATUS - YES / NO

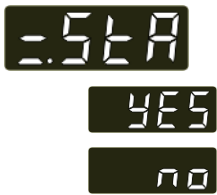

In the second submenu the ATC function for the temperature sensor selected above is activated >YES< or deactivated >NO<.

>YES< (factory setting) The controller of the circulator uses the original curve of the temperature sensor or the new curve measured during the ATC calibration.

Important: Set to >NO< during the calibration process

>NO< An ATC calibration is to be carried out.

Important: Set to >YES< after calibration.

ⓘ In the > ATC STATUS < >YES< the ATC calibration always affects the current working temperature; also the one set via interface.

9.5.2. ATC - TYPE: 1 -/ 2 -/ 3 POINT



A >1-point<, >2-point< or >3-point< calibration can be carried out.

First geometrically define the location for calibration (measuring point CT), then determine the temperature values of the calibration points. The type of calibrations also determines the number of the following pairs of values indicated on the MULTI-DISPLAY (LED)..



Pairs of values:

tt X: Circulator temperature 1 or 2 or 3 (actual value TT)

The actual temperature of the bath is simultaneously saved with the "calibration value" >CALVAL< and can be indicated for control purposes (value does not flash).



Ct X: Calibration temperature 1 or 2 or 3 (actual value CT)

The „calibration value“ is determined with a temperature measuring device and saved under menu item >CALVAL<.



(value flashes $\overline{||}$)

9.5.3. Example: 3-point calibration for internal control

In the temperature range from 80 °C to 160 °C the calibration curve of the temperature sensor (TT) is to be adjusted to the actual temperatures at measuring point (CT).

1. Set working temperature setpoint :

Refer to „Direct temperature setting “ page 24



80.00 °C
120.00 °C
160.00 °C

1. By pressing the key **T** or **▲** the circulator switches to the active >SETPOINT< see example on the left: >t1 25.00°C<.

The integer digits flash **|||** (Example: <25>).

2. Change the value to 80.00 °C by pressing the keys **▼** and **▲** and

confirm by pressing the key **OK** .
The decimal digits flash.

Confirm once more by pressing the key **OK** .

3. The bath is heated up.

Wait for approx. 5 minutes until the temperature is constant.

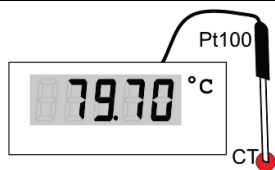

2. Reading of temperature measuring device

Read the value of measuring point CT on the device and enter under menu item >Ct X< by using the keypad.

- >Ct 1< (79.70 °C)
- >Ct 2< (119.5 °C)
- >Ct 3< (159.3 °C)

3. Calibration

Menu level 1



① Press the **↺** key if parameter is to be retained. Correction function for parameters or values (prior to OK).

① **👁** Setting is required only for the first calibration point.

Level 2



Parameter level

































An ATC calibration is to be carried out.
Set to >no<
The parameter flashes, switch by pressing **▲▼** and **OK** .

















- The parameter flashes, switch by pressing **▲▼** and **OK** .

A >3-point< calibration is carried out.

	 	<p>The value >tt1< is only indicated</p> <p>Setting >Ct 1< by using the keys.</p> <ul style="list-style-type: none"> Integer digits flash, set by pressing   (79) +  Decimal digits flash, set by pressing   (70) +  <p>The first of 3 points is calibrated.</p>
<p>Return to 1. Set working temperature value: 120.00 °C</p>		
		<p>The value >tt2< is only indicated</p>
		<p>Setting >Ct 2< by using the keys.</p> <ul style="list-style-type: none"> Integer digits flash, set by pressing   (119) +  Decimal digits flash, set by pressing   (5) +  <p>The second of 3 points is calibrated.</p>
<p>Return to 1. Set working temperature value: 160.00 °C</p>		
		<p>The value >tt3< is only indicated</p>
		<p>Setting >Ct 3< by using the keys.</p> <ul style="list-style-type: none"> Integer digits flash, set by pressing   (159) +  Decimal digits flash, set by pressing   (3) +  <p>The 3-point calibration is completed</p>
<p>4. Return to standard operation</p>		
		<ul style="list-style-type: none"> Set >YES< after calibration. (Standard operation)

9.6. MENU LIMITS

<p>Menu level 1</p> 	<p>>Li< = LIMITS – limitation of operating temperature range Maximum and minimum setpoint Restriction of the adjustable temperature range.</p>	
<p>Level 2</p>	<p>Parameter level</p>	<p>Press the  key if parameter is to be retained. Correction function for parameters or values (prior to OK).</p>
		<ul style="list-style-type: none"> • Integer digits flash, set by pressing  +  • Decimal digits flash, set by pressing  + 
		<ul style="list-style-type: none"> • Integer digits flash, set by pressing  +  • Decimal digits flash, set by pressing  + 

Factory settings::

 200 °C
(Setpoint High)

 -50 °C
(Setpoint Low)

The limitation of the operating temperature range effects the temperature setting in the menu with the key .

Only setting of working temperatures which lie within the determined limits is possible

This applies to settings in the MENU .

   (refer to page 24)

and for settings in the MENU 
high temperature low temperature

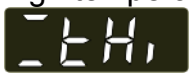
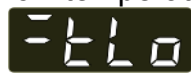
  (refer to page 29)

The temperature values are automatically deferred into the limit range.

Setting range: -50,0 °C ... +200,0 °C

10. Troubleshooting guide / error messages



Alarm with complete shutdown:

If one of the following failures occur a complete, all-pole shutdown of the heater and circulating pump is effected.

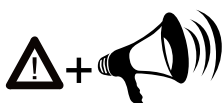

„!“ lights up and a continuous signal sounds.

The code for the cause of alarm is indicated on the MULTI-DISPLAY (LED).



Warning without a complete shutdown of the unit

The MULTI-DISPLAY (LED) indicates the cause for the warning in form of a code and an acoustic signal sounds in regular intervals. These messages appear every 10 seconds.



Press the key **OK** to stop the signal



Low level alarm

The circulator is operated without or insufficient bath fluid.

Switch the unit off with the mains switch, refill bath fluid and switch on!

Tube breakage has occurred (insufficient filling level of bath fluid caused by pumping-out)

Replace the tubing and refill bath liquid.

The float is defect (e.g. transport damage).

Repair by authorized JULABO service personnel.



During the self-test after switch-on a short –circuit is detected between pin 2 and pin 4 of the control line or the control line was disconnected during operation.

Reconnect the control line or repair short-circuit.



Excess temperature warning

or

Excess temperature alarm

Type of warning: set to >0 = warning< or >1 = alarm<



Low temperature warning

or

Low temperature alarm.

Typ of warning: set to >0 = warning< or >1 = alarm<



- Cable of working temperature sensor is disconnected or short-circuited.



Defect of working or excess temperature protector.

Working temperature sensor and excess temperature protector report a temperature difference of more than 35 K.



Other errors

Internal hardware error – call service



Error in A/D converter



Excess temperature protector defect.
The protection temperature is below the set working temperature setpoint.
Set the protection temperature to a higher value.



The cable of the excess temperature protector has been disconnected or short-circuited



The early warning system for low level reports a critical fluid level. Refill bath fluid.

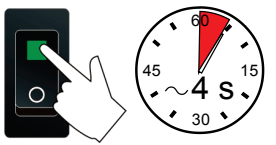

A By quickly switching off and restarting the unit the alarm is cancelled.
If the error occurs once more after the restart, a remote diagnosis is required.



„**Configuration Error**“
The configuration of the circulator does not correspond with its current application.
Press the **OK** key for a non-recurring, automatic change of the configuration.
In this case please call the JULABO Technical Service or an authorized dealer.

Disturbances that are not indicated.

The electronic pump motor is overload-protected by an electronic current limiter. If viscosity of the bath fluid is or becomes too high, the motor stops running.

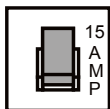

Mains circuit breakers (resettable) 15 A

11. Electrical connections



Notice:

Use shielded cables only. The shield of the connecting cable is electrically connected to the plug housing. The unit ensures safe operation if connecting cables with a maximum length of 3 m are used. The use of longer cables does not affect proper performance of the unit, however external interferences may have a negative impact on safe operation (e.g. cellular phones).



 / Control output

The  connector may be used for control of JULABO refrigerated circulators or as output for alarm messages.

Circuit: Operation = relay powered
 Alarm = relay not powered

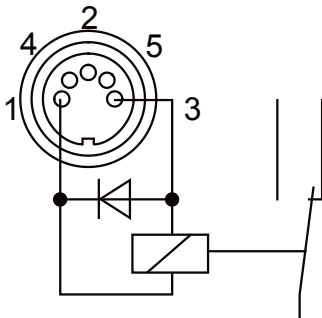

Pin assignment:

Pin	Signal
1	+24 V (I max. current 25 mA)
2	0 V
3	Alarm relay
4	Reserved - do not use!
5	Cooling pulse

RS232 serial interface

This port can be used to connect a computer with an RS232 cable for remote control of the circulator.

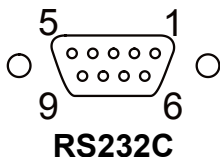

Pin assignments RS232:

Pin 2	RxD	Receive Data
Pin 3	TxD	Transmit Data
Pin 5	0 V	Signal GND
Pin 7	RTS	Request to send
Pin 8	CTS	Clear to send

Pin 1; 4; 6, 9 Reserved - do not use!

RS232 interface cable

Circulator (9-pol)		PC (9-pol)
Pin 2 RxD	↔	Pin 3 TxD
Pin 3 TxD	↔	Pin 2 RxD
Pin 5 GND	↔	Pin 5 GND
Pin 7 RTS	↔	Pin 8 CTS
Pin 8 CTS	↔	Pin 7 RTS

Accessories:	Order No.	Description
	8 980 073	RS232 interface cable 9-pol./9-pol. , 2,5 m
	8 900 110	USB interface adapter cable

12. Remote control

12.1. Setup for remote control

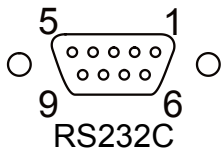

- Check the interface parameters for both interfaces (on circulator and PC) and make sure they match. (Serial interface refer to page 36.)
- In the menu >CFG< (Configuration) set the menu item >rt< (Remote) to >ON< . (refer to page 33).
- Connect both units with an interface cable.



Like all parameters which can be entered through the keypad, interface parameters are stored in memory even after the circulator is turned off.

12.2. Communication with a PC or a superordinated data system



If the circulator is put into remote control mode via the configuration level, the MULTI-DISPLAY (LED) will read „r OFF“ = REMOTE STOP. The circulator is now operated via the computer. In general, the computer (master) sends commands to the circulator (slave). The circulator sends data (including error messages) only when the computer sends a query.



In remote control mode, the start command and all values to be set must be resent by the PC via the interface in case of a power interruption.

AUTOSTART is not possible.

A transfer sequence consists of:

- command
- space (↔; Hex: 20)
- parameter (decimal separation with a period)
- end of file (↵; Hex: 0D)

The commands are divided into **in** and **out** commands.

in commands: retrieve parameters

out commands: set parameters



The **out** commands are valid only in remote control mode.

Command to set the working temperature > t 1< to 55.5 °C

out_sp_00 ↔ 55.5↵

Command to retrieve the working temperature > t 1<

in_sp_00↵

Response from the circulator: **55.5↵**

12.3. List of commands

out commands: Setting parameters or temperature values.

Command	Parameter	Response of circulator
version	None	Number of software version (V X.xx)
status	none	Status message, error message (see page 48)
out_mode_01	0	Use working temperature >t 1<
out_mode_01	1	Use working temperature >t 2<
out_mode_01	2	Use working temperature >t 3<
out_mode_05	0	Stop the unit = R –OFF-.
out_mode_05	1	Start the unit.
out_sp_00	xxx.xx	Set working temperature. „t 1“
out_sp_01	xxx.xx	Set working temperature. „t 2“
out_sp_02	xxx.xx	Set working temperature. „t 3“
out_sp_03	xxx.xx	Set high temperature warning limit „t High“
out_sp_04	xxx.xx	Set low temperature warning limit „t Low“
out_sp_07	x	Set the pump pressure stage. (1 ... 4)
out_par_06	xxx	Xp control parameter of the internal controller.
out_par_07	xxx	Tn control parameter of the internal controller.
out_par_08	xxx	Tv control parameter of the internal controller.

in commands: Asking for parameters or temperature values to be displayed.

Command	Parameter	Response of circulator
in_pv_00	none	Actual bath temperature.
in_pv_01	none	Heating power being used (%).
in_pv_03	none	Temperature value registered by the safety sensor.
in_pv_04	none	Setpoint temperature („SafeTemp“) of the excess temperature protection
in_sp_00	none	Working temperature „t 1“
in_sp_01	none	Working temperature „t 2“
in_sp_02	none	Working temperature „t 3“

Remote control

Command	Parameter	Response of circulator
in_sp_03	none	High temperature warning limit „t High“
in_sp_04	none	Low temperature warning limit „t Low“
in_sp_07	none	Pump pressure stage
in_par_01	none	Te - Time constant of the external bath.
in_par_02	none	Si - Internal slope
in_par_03	none	Ti - Time constant of the internal bath.
in_par_06	none	Xp control parameter of the internal controller.
in_par_07	none	Tn control parameter of the internal controller.
in_par_08	none	Tv control parameter of the internal controller.
in_mode_01	none	Selected setpoint: 0 = Setpoint „t 1“ 1 = Setpoint „t 2“ 2 = Setpoint „t 3“
in_mode_05	none	Circulator in Stop/Start condition: 0 = Stop 1 = Start

12.4. Status messages

Status messages	Description
00 MANUAL STOP	Circulator in „OFF“ state.
01 MANUAL START	Circulator in keypad control mode.
02 REMOTE STOP	Circulator in „r OFF“ state.
03 REMOTE START	Circulator in remote control mode.

12.5. Error messages

ERROR MESSAGES	Description
-01 LOW LEVEL ALARM	Low liquid level alarm.
-02 REFRIGERATOR ALARM	Control cable of the refrigerated circulator or MVS solenoid valve controller short-circuited or interrupted.
-03 EXCESS TEMPERATURE WARNING	High temperature warning.
-04 LOW TEMPERATURE WARNING	Low temperature warning.
-05 WORKING SENSOR ALARM	Working temperature sensor short-circuited or interrupted.

ERROR MESSAGES	Description
-06 SENSOR DIFFERENCE ALARM	Sensor difference alarm. Working temperature and safety sensors report a temperature difference of more than 35 K.
-07 I2C-BUS ERROR	Internal error when reading or writing the I2C bus.
-08 INVALID COMMAND	Invalid command.
-09 COMMAND NOT ALLOWED IN CURRENT OPERATING MODE	Invalid command in current operating mode.
-10 VALUE TOO SMALL	Entered value too small.
-11 VALUE TOO LARGE	Entered value too large.
-12 TEMPERATURE MEASUREMENT ALARM	Error in A/D converter.
-13 WARNING : VALUE EXCEEDS TEMPERATURE LIMITS	Value lies outside the adjusted range for the high and low temperature warning limits. But value is stored.
-14 EXCESS TEMPERATURE PROTECTOR ALARM	Excess temperature protection alarm
-20 WARNING: CLEAN CONDENSOR OR CHECK COOLING WATER CIRCUIT OF REFRIGERATOR	Cooling of the condenser is affected. Clean air-cooled condenser. Check the flow rate and cooling water temperature on water-cooled condenser.
-21 WARNING: COMPRESSOR STAGE 1 DOES NOT WORK	Compressor stage 1 does not work.
-22 WARNING: COMPRESSOR STAGE 2 DOES NOT WORK	Compressor stage 2 does not work.
-23 WARNING: HIGH TEMPERATURE ON COMPRESSOR STAGE 1	Excess temperature on compressor stage 1.
-24 WARNING: HIGH TEMPERATURE ON COMPRESSOR STAGE 2	Excess temperature on compressor stage 2.
-25 REFRIGERATOR WARNING	Error in the refrigerating machine.
-30 CONFIGURATION ERROR: CONFIRM BY PRESSING <ENTER> ON CIRCULATOR	The configuration of the circulator does not conform to its present use. Press OK to automatically perform a single modification of the configuration.
-33 SAFETY SENSOR ALARM	Excess temperature sensor short-circuited or interrupted.
-40 NIVEAU LEVEL WARNUNG	Low liquid level warning in the internal reservoir.

13. JULABO Service – Online remote diagnosis

JULABO circulators of the HighTech series are equipped with a black box. This box is implemented in the controller and records all significant data for the last 30 minutes. In case of a failure, this data can be read out from the unit by using special software. This software is available as a **free** download from www.julabo.com \ EasyBlackBox.

- Installation is easy and is performed step by step. Please observe the instructions.



- Data read-out is possible in the conditions "OFF", "R OFF" or "ALARM".
- Connect the circulator to the computer using an interface cable.
- Start the EasyBlackBox program. The program asks for the port used (COM1,) and the baud rate of the unit. You do not have this information on hand? Simply try it out! The program continues to send the request until the correct settings are made.

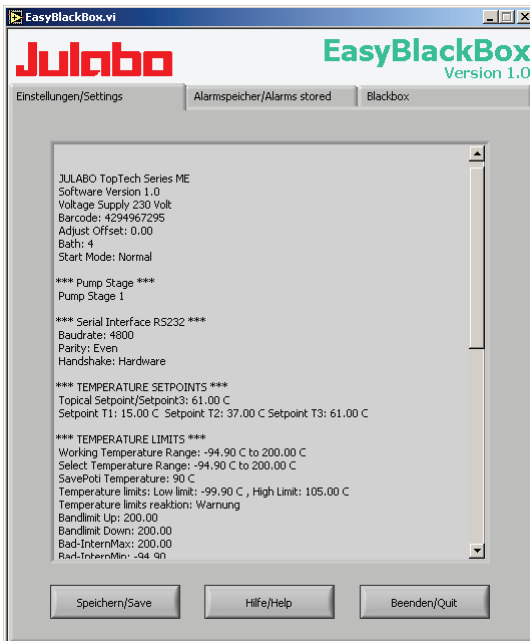

- Data is read out and shown on the monitor divided into the sections >Einstellungen/Settings<, >Alarmspeicher/Alarms stored<, >Blackbox<
 - ← see example
- After pressing >Speichern/Save<, a text file is created. The program suggests a filename - >C:\model description and barcode no.<. Modifications are possible.
- E-mail this file to service@julabo.com, JULABO's service department. JULABO is thus able to provide rapid support.

14. Cleaning / repairing the unit



Caution:

- Always turn off the unit and disconnect the mains cable from the power source before cleaning the unit.
- Prevent humidity from entering into the circulator.
- Electrical connections and any other work must be performed by qualified personnel only.

Cleaning:

For cleaning the bath tank and the immersed parts of the circulator, use low surface tension water (e.g., soap suds). Clean the outside of the unit using a wet cloth and low surface tension water.

The circulator is designed for continuous operation under normal conditions. Periodic maintenance is not required.

The tank should be filled only with a bath fluid recommended by JULABO. To avoid contamination, it is essential to change the bath fluid from time to time.

Repairs

Before asking for a service technician or returning a JULABO instrument for repair, please contact an authorized JULABO service station.

When returning the unit:

- Clean the unit in order to avoid any harm to the service personnel.
- Attach a short fault description.
- During transport the unit has to stand upright. Mark the packing correspondingly.
- When returning a unit, take care of careful and adequate packing.
- JULABO is not responsible for damages that might occur from insufficient packing.



JULABO reserves the right to carry out technical modifications with repairs for providing improved performance of a unit.